

# SISTEMA DE FIXAÇÃO POR GRAMPO-PARAFUSO

## CKJNR

Suporte para torneiar  $93^\circ$  com pastilha positiva  $55^\circ$









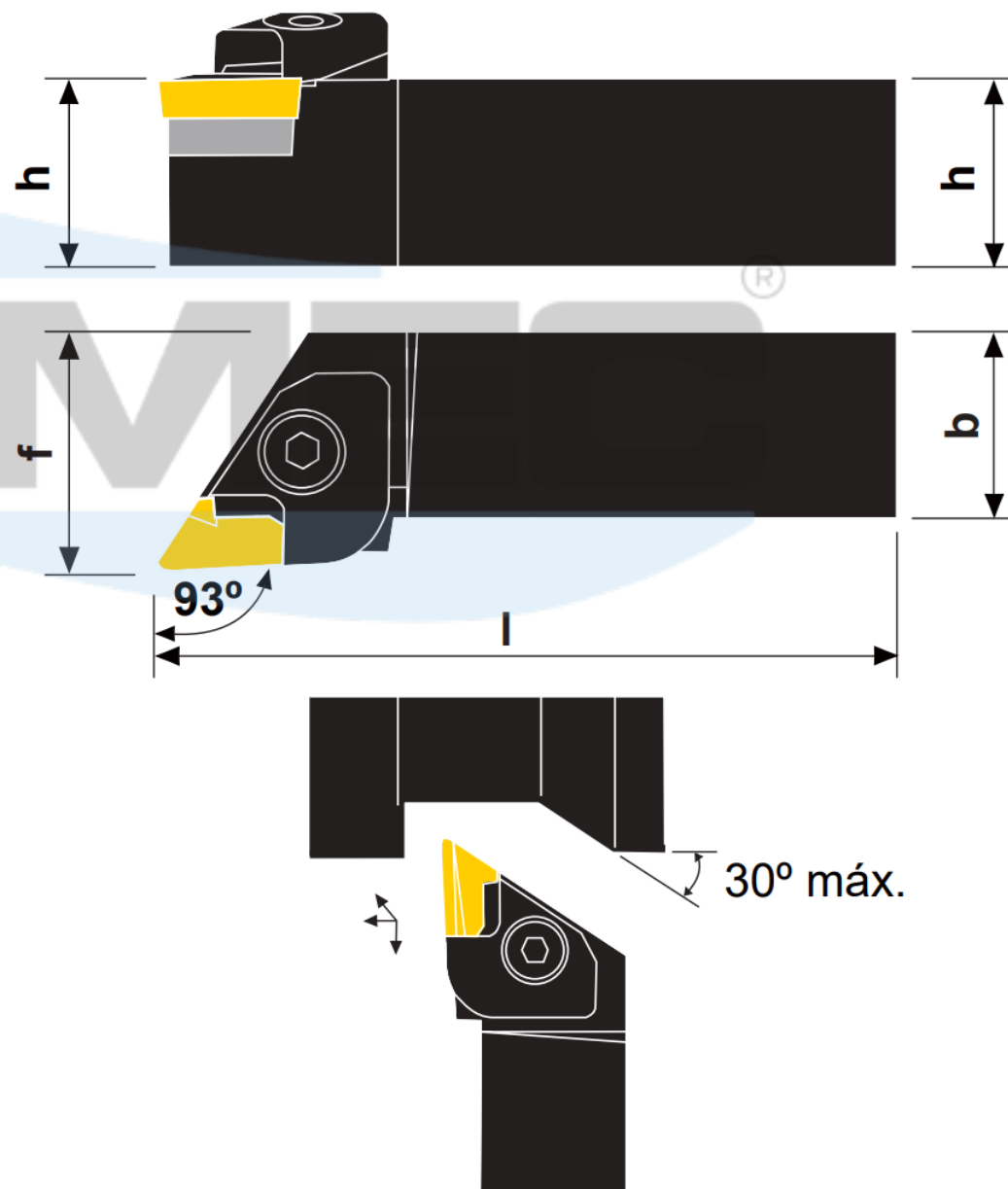
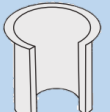

Ilustração na versão direita

Produtos	Dimensões (mm)				Pastilha 	Acessórios						
	h	b	l	f		Grampo 	Paraf. do Grampo 	Mola 	Pino c/ mola 	Calço 	Rebite 	Chave Allen 
CKJNR/L 2020 K16	20	20	125	25	KNUX 1604_ER KNUX 1604_EL	170.5-824 170.5-825	170.5-865	170.5-848M	170.5-841	R170.5-5.851 L170.5-851	174.1-866	C - 4
CKJNR/L 2525 M16	25	25	150	32								
CKJNR/L 3225 P16	32	25	170	32								
CKJNR/L 3232 P16	32	32	170	40								