

SISTEMA DE FIXAÇÃO DUPLO POR PINO E GRAMPO

MSBNR

Suporte para torneiar 75° com pastilha negativa quadrada

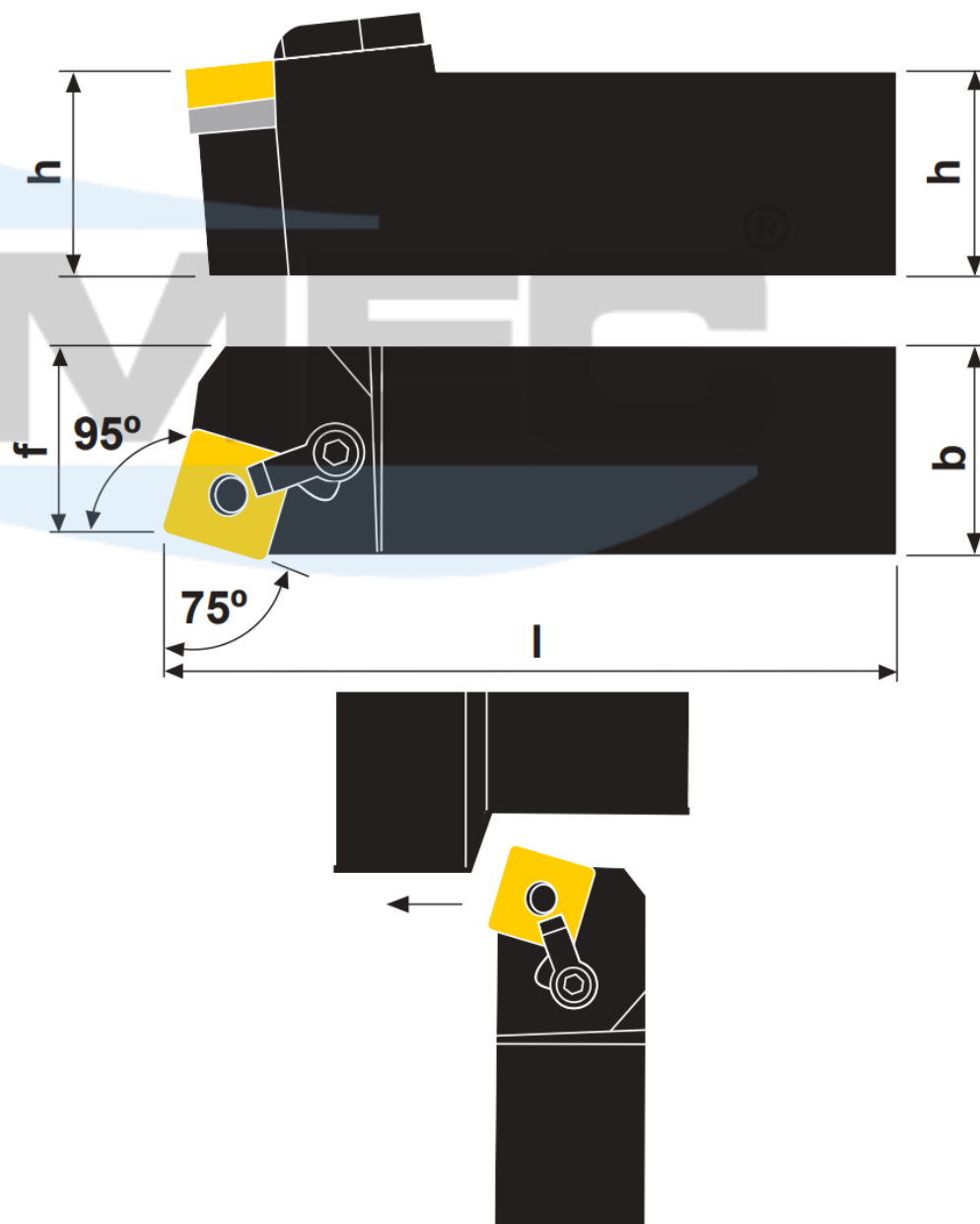

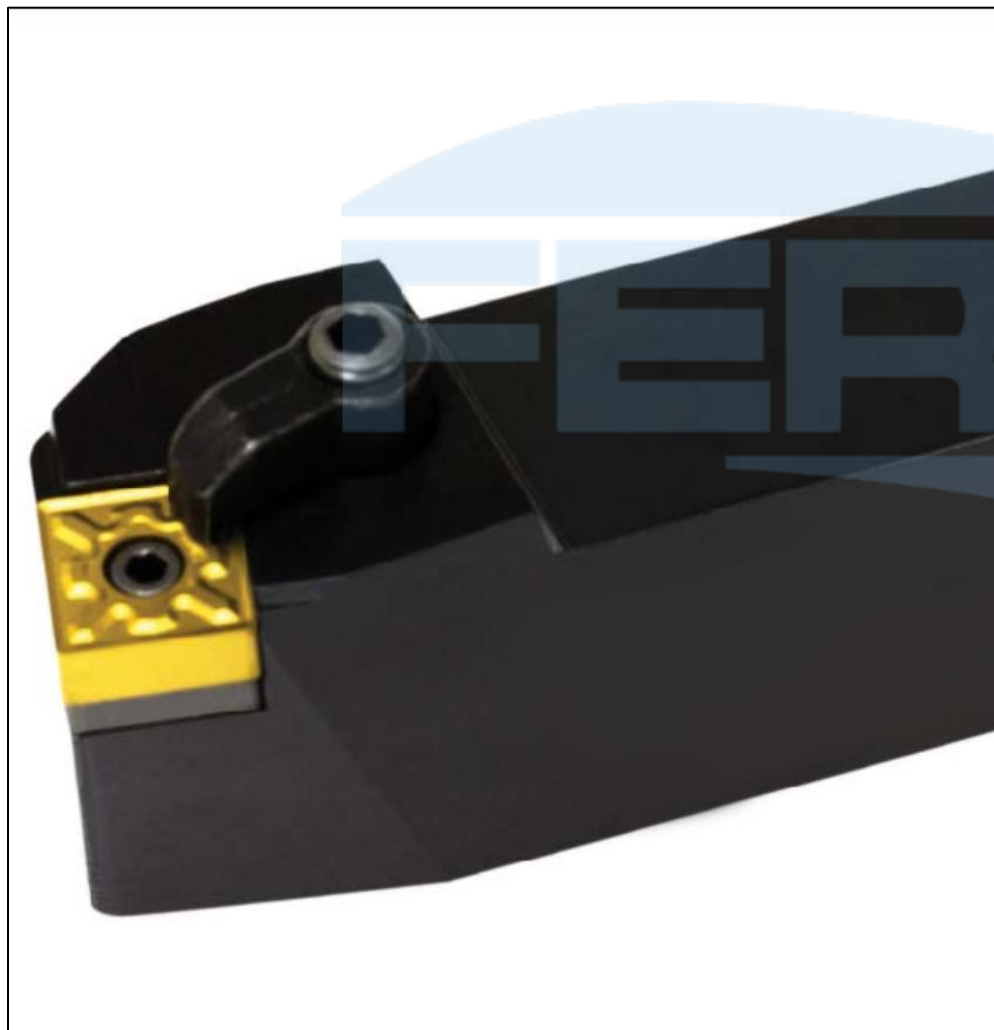
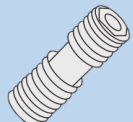
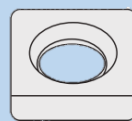
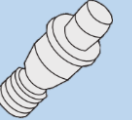

Ilustração na versão direita

Produtos	Dimensões (mm)				Pastilha	Acessórios				
	h	b	l	f			 Grampo	 Parafuso	 Calço	 Pino Paraf. do Calço
MSBNR/L 2020 K12	20	20	125	17	SN_1204 SNGN 1204	NC-20 NC-23	HT-1	ISSN-423	NL-46 PS-46	C - 3/32 C - 1/8
MSBNR/L 2525 M12	25	25	150	22						
MSBNR/L 3225 P12	32	25	170	22						
MSBNR/L 3232 P12	32	32	170	27	SN_1506 SNGN 1506	NC-9 NC-12	HT-2	ISSN-543	NL-58 PS-58	C - 1/8 C - 4
MSBNR/L 4040 S15	40	40	250	35						
MSBNR/L 3232 P19	32	32	170	27	SN_1906 SNGN 1906	NC-9 NC-30	HT-2	SSN-64C	H312-1C H312-1CH	C - 4
MSBNR/L 4040 S19	40	40	250	35						