

SISTEMA DE FIXAÇÃO POR ALAVANCA

PTGNR

Suporte para torneiar 91° com pastilha negativa triangular

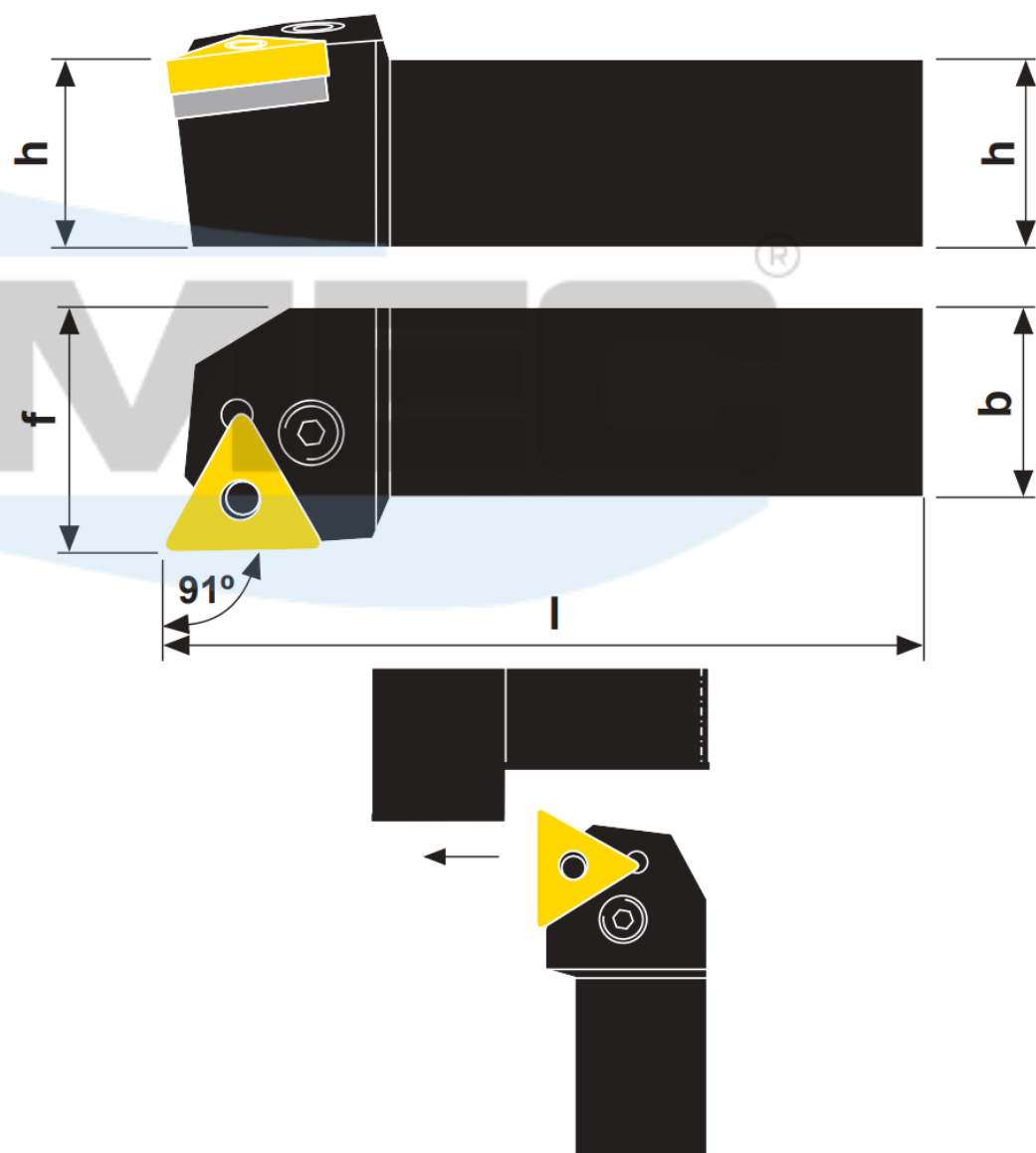

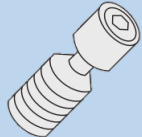
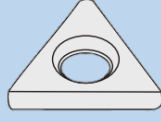
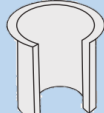
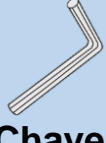

Ilustração na versão direita

Produtos	Dimensões (mm)				Pastilha	Acessórios				
	h	b	l	f		 Alavanca	 Parafuso	 Calço	 Rebite	 Chave Allen
PTGNR/L 1010 E11	10	10	70	15	TN_1103	174.3-846-1	174.3-829	-	-	C - 5/64
PTGNR/L 1212 F11	12	12	80	16						
PTGNR/L 1616 H11	16	16	100	20						
PTGNR/L 1616 H16	16	16	100	20	TN_1604	174.3-840M	174.3-820M	179.3-850M	174.3-860	C - 2,5
PTGNR/L 2020 K16	20	20	125	25						
PTGNR/L 2525 M16	25	25	150	32						
PTGNR/L 3225 P16	32	25	170	32	TN_2204	174.3-841M	174.3-821	179.3-852M	174.3-861	C - 3,0
PTGNR/L 2525 M22	25	25	150	32						
PTGNR/L 3225 P22	32	25	170	32						
PTGNR/L 3232 P22	32	32	170	40	TN_2706	174.3-843M	174.3-825	179.3-854M	174.3-864	C - 3,0
PTGNR/L 4040 S27	40	40	250	50						