

# SISTEMA DE FIXAÇÃO POR ALAVANCA

## PSBNR

Suporte para tornear 75° com pastilha negativa quadrada

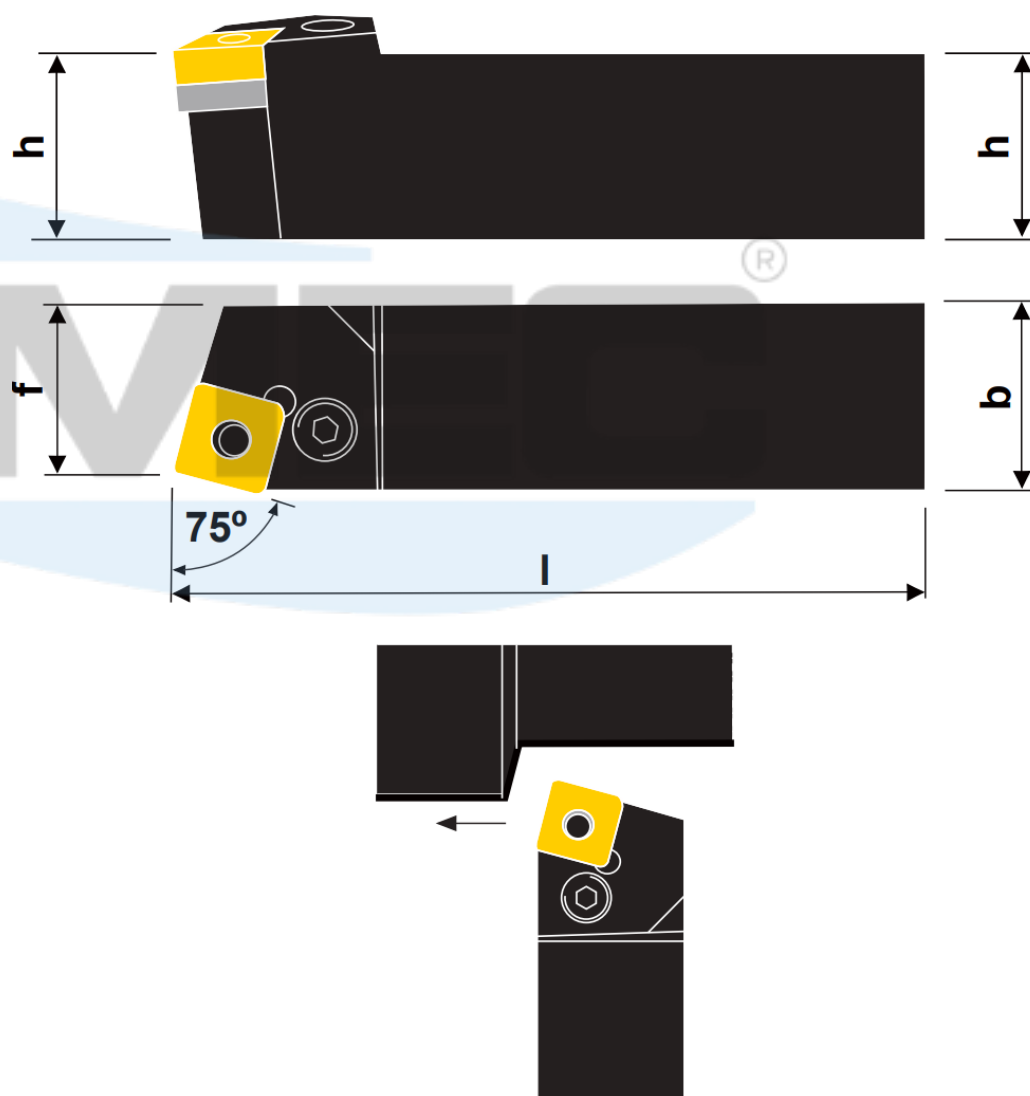

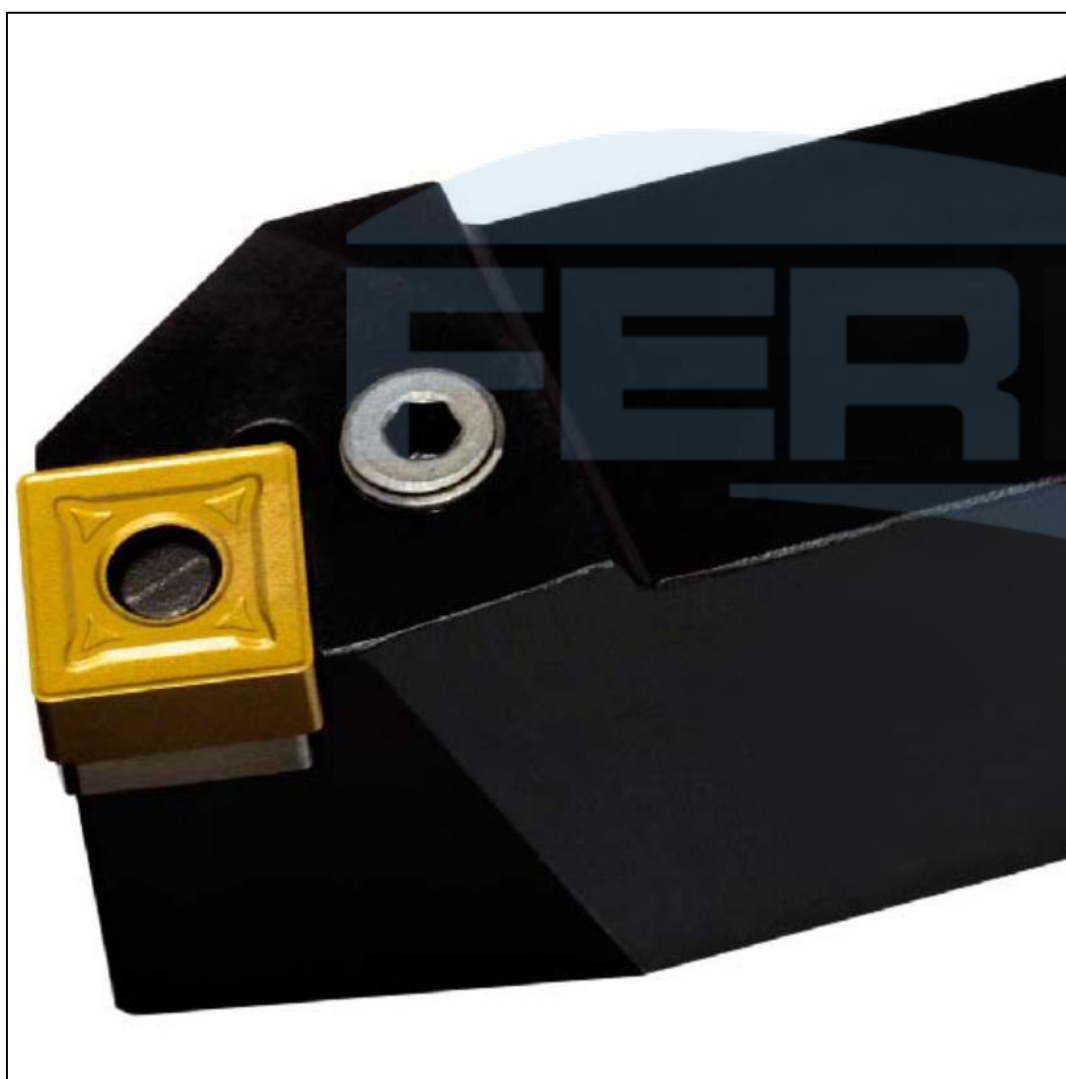
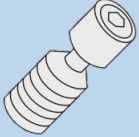

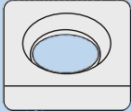
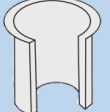

Ilustração na versão direita

Produtos	Dimensões (mm)				Pastilha	Acessórios				
	h	b	l	f						
PSBNR/L 1616 H09	16	16	100	13	SN_0903	174.3-840M	174.3-820M	174.3-850	174.3-863	C - 2,5
PSBNR/L 2020 K09	20	20	125	17						
PSBNR/L 2020 K12	20	20	125	17	SN_1204	174.3-841M	174.3-821	174.3-851M	174.3-861	C - 3,0
PSBNR/L 2525 M12	25	25	150	22						
PSBNR/L 3225 P12	32	25	170	22	SN_1506	438.3-840	438.3-831	174.3-857	174.3-864	C - 3,0
PSBNR/L 2525 M15	25	25	150	22						
PSBNR/L 3232 P15	32	32	170	27	SN_1906	174.3-842M	174.3-822M	174.3-852M	174.3-862	C - 4,0
PSBNR/L 3232 P19	32	32	170	27						
PSBNR/L 4040 S19	40	40	250	35	SN_2507	174.3-844M	174.3-827	174.3-853M	174.3-865	C - 5,0
PSBNR/L 4040 S25	40	40	250	35						
PSBNR/L 5050 T25	50	50	300	43						