

# SISTEMA DE FIXAÇÃO RÍGIDA

## DSSNR

Suporte para torneiar e facear 45° com pastilha negativa quadrada











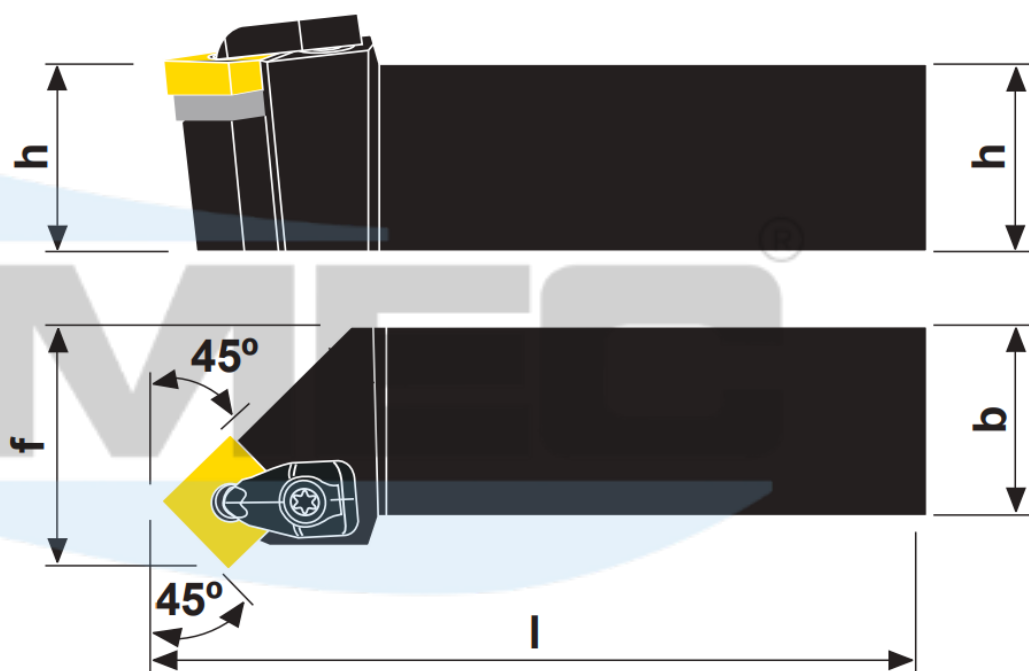
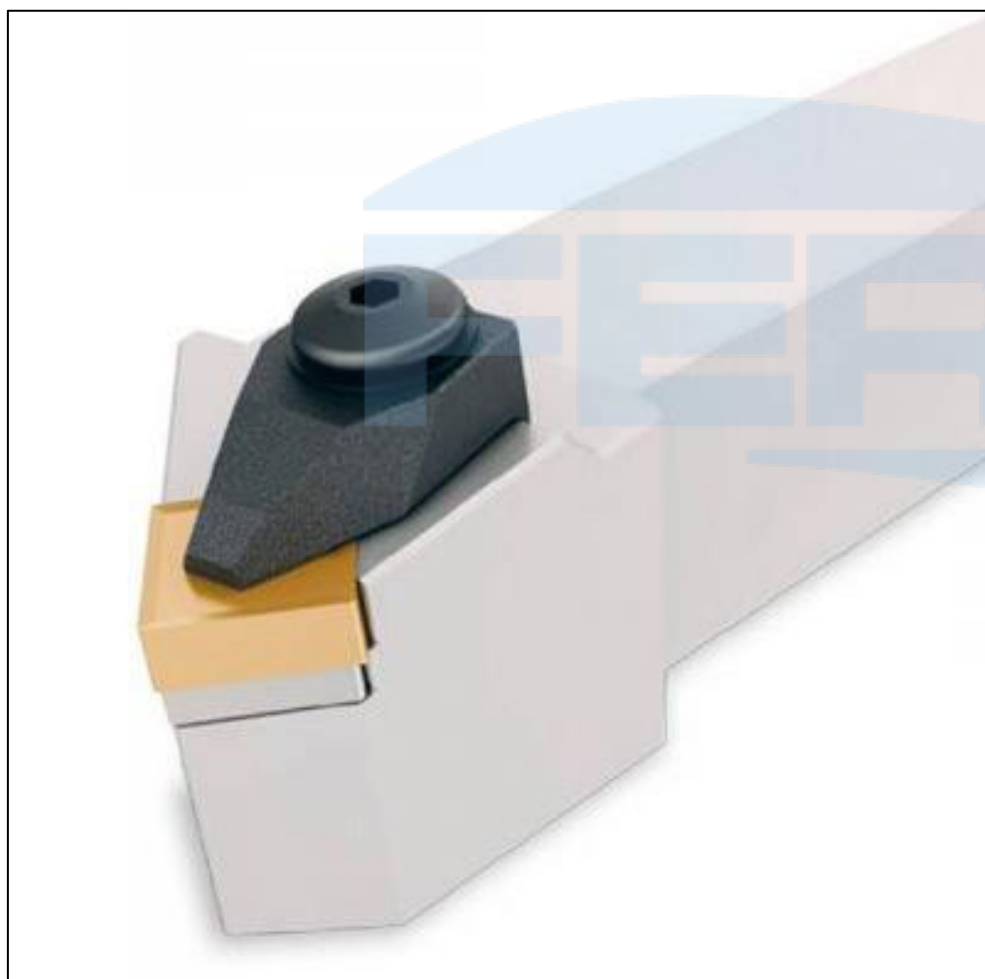
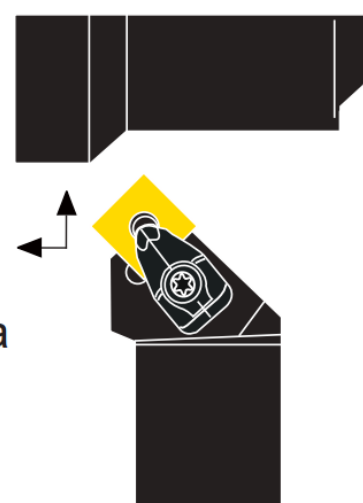



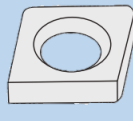
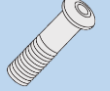



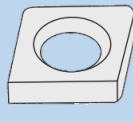
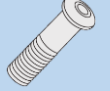





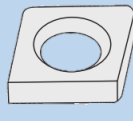
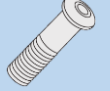





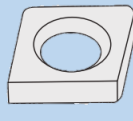
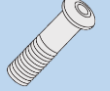





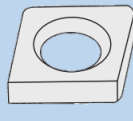
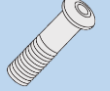

Ilustração na versão direita

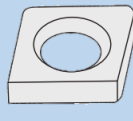
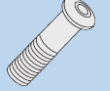

Produtos	Dimensões (mm)				Pastilha	Acessórios						
	h	b	l	f			 Grampo	 Paraf. do Grampo	 Calço	 Paraf. do Calço	 Pino	 Mola
DSSNR/L 1616 H09	16	16	100	20	SN_0903							
DSSNR/L 2020 K09	20	20	125	25								
DSSNR/L 2525 M09	25	25	150	32								
DSSNR/L 2020 K12	20	20	125	25	SN_1204							
DSSNR/L 2525 M12	25	25	150	32								
DSSNR/L 3225 P12	32	25	170	32								
DSSNR/L 2525 M15	25	25	150	32	SN_1506							
DSSNR/L 3232 P15	32	32	170	40								
DSSNR/L 3232 P19	32	32	170	40	SN_1906							
DSSNR/L 4040 S19	40	40	250	50								
DSSNR/L 4040 S25	40	40	250	50	SN_2507							
DSSNR/L 5050 T25	50	50	300	60								