

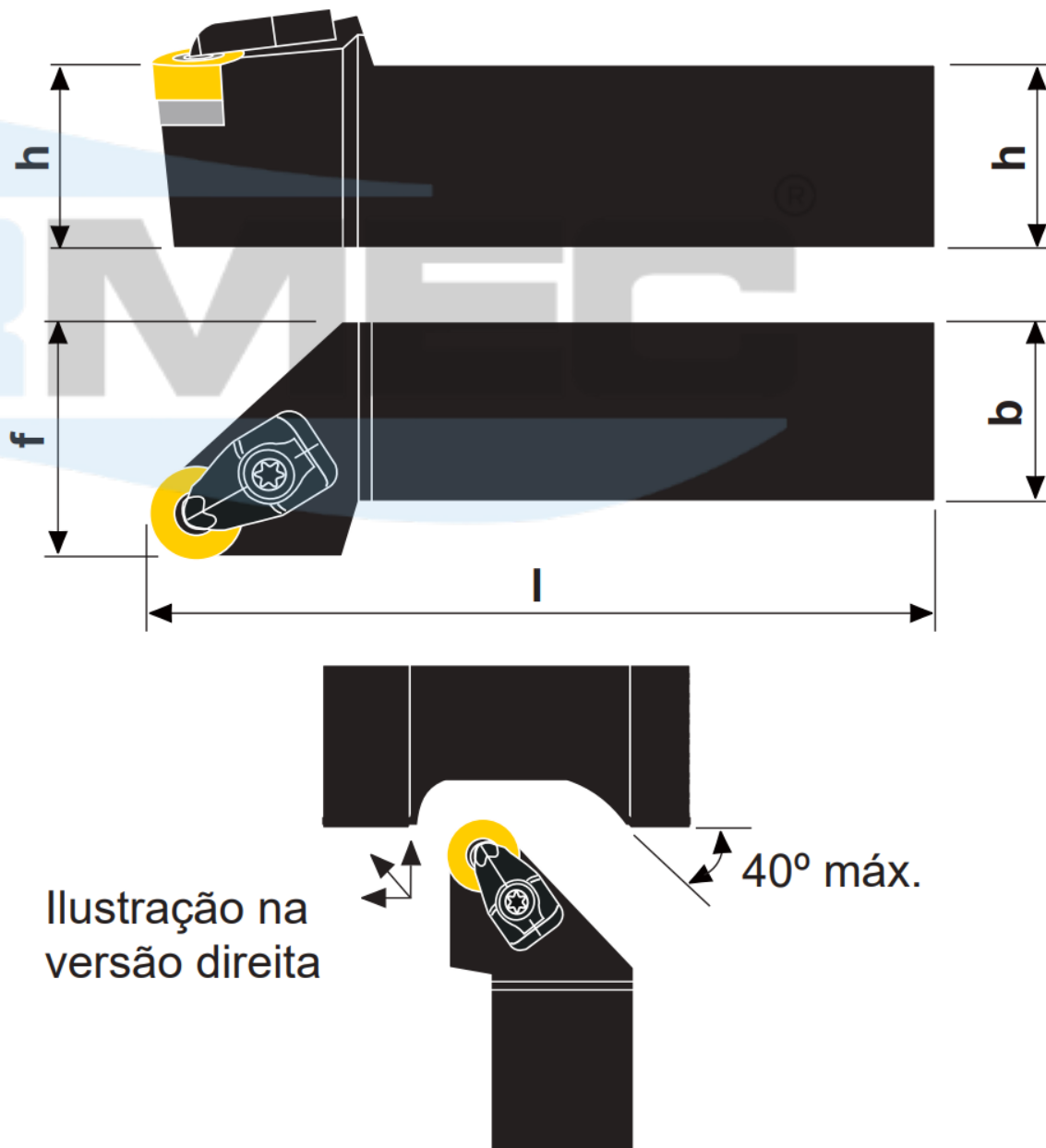





SISTEMA DE FIXAÇÃO RÍGIDA

DRSNR

Suporte para torneiar e facear com pastilha negativa redonda

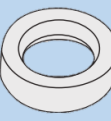
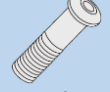
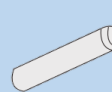

Produtos	Dimensões (mm)				Pastilha	Acessórios						
	h	b	l	f			 Grampo	 Paraf. do Grampo	 Calço	 Paraf. do Calço	 Pino	 Mola
DRSNR/L 2020 K09	20	20	125	25	RN_0903	5412 028-01	5412 086-01	5322 156-01	5513 020-04	5412 030-255	5412 001-57	T09-F
DRSNR/L 2525 M09	25	25	150	32								
DRSNR/L 2020 K12	20	20	125	25	RN_1204	5412 028-02	5412 086-02	5322 155-02	5513 020-02	5412 030-307	5412 001-58	T15-F
DRSNR/L 2525 M12	25	25	150	32								
DRSNR/L 3225 P15	32	25	170	32	RN_1506	5412 028-03	5412 086-03	5322 155-04	5513 020-07	5412 030-307	5412 001-59	T20-F
DRSNR/L 3232 P19	32	32	170	40	RN_1906	5412 028-04						
DRSNR/L 4040 S25	40	40	250	50	RN_2509	5412 028-05	5412 086-04	5322 155-07	5513 020-08	5412 001-61	T25-F	