

# SISTEMA DE FIXAÇÃO RÍGIDA

## DDNNN

Suporte neutro para torneiar e facear 62°30' com pastilha 55°











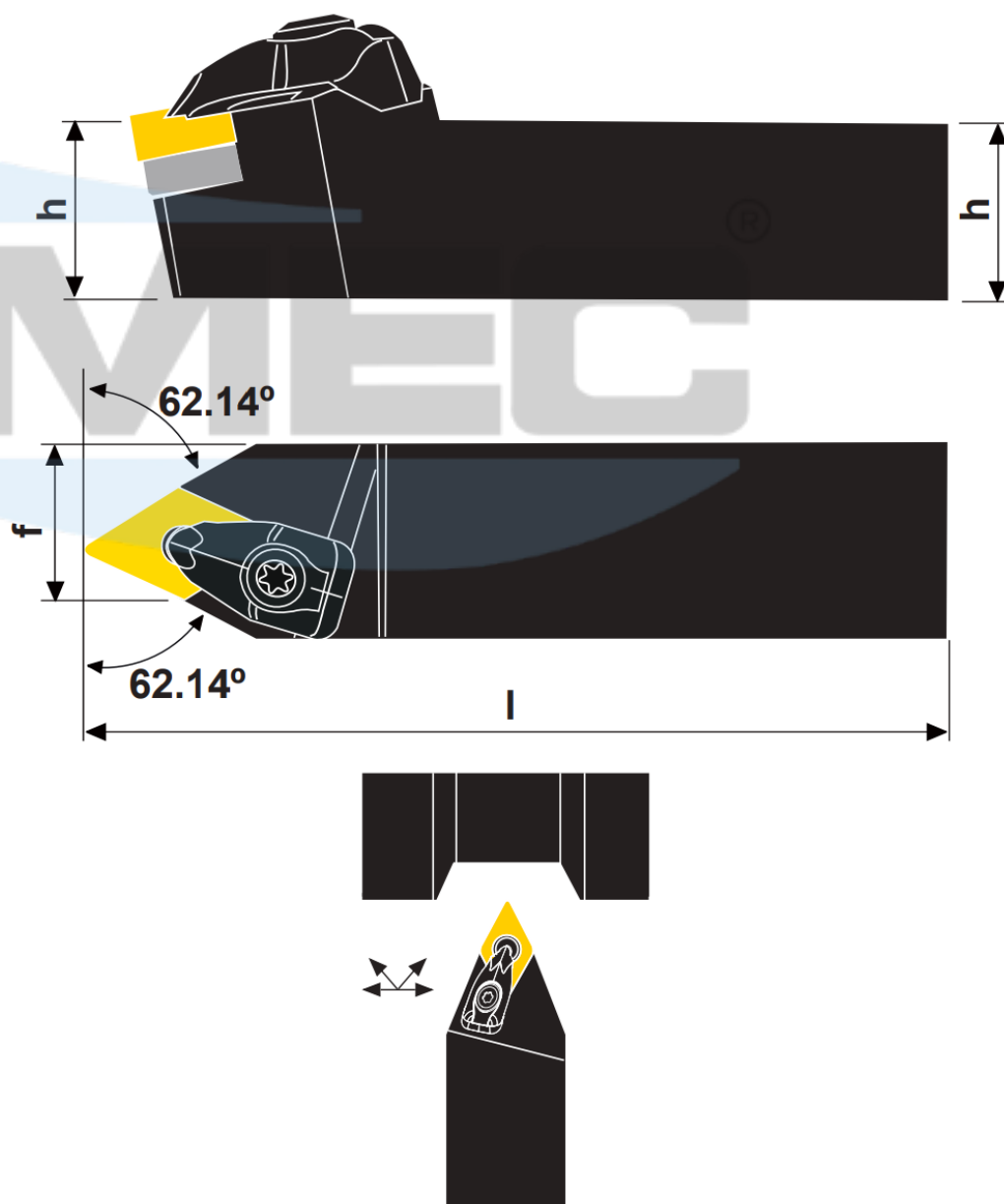
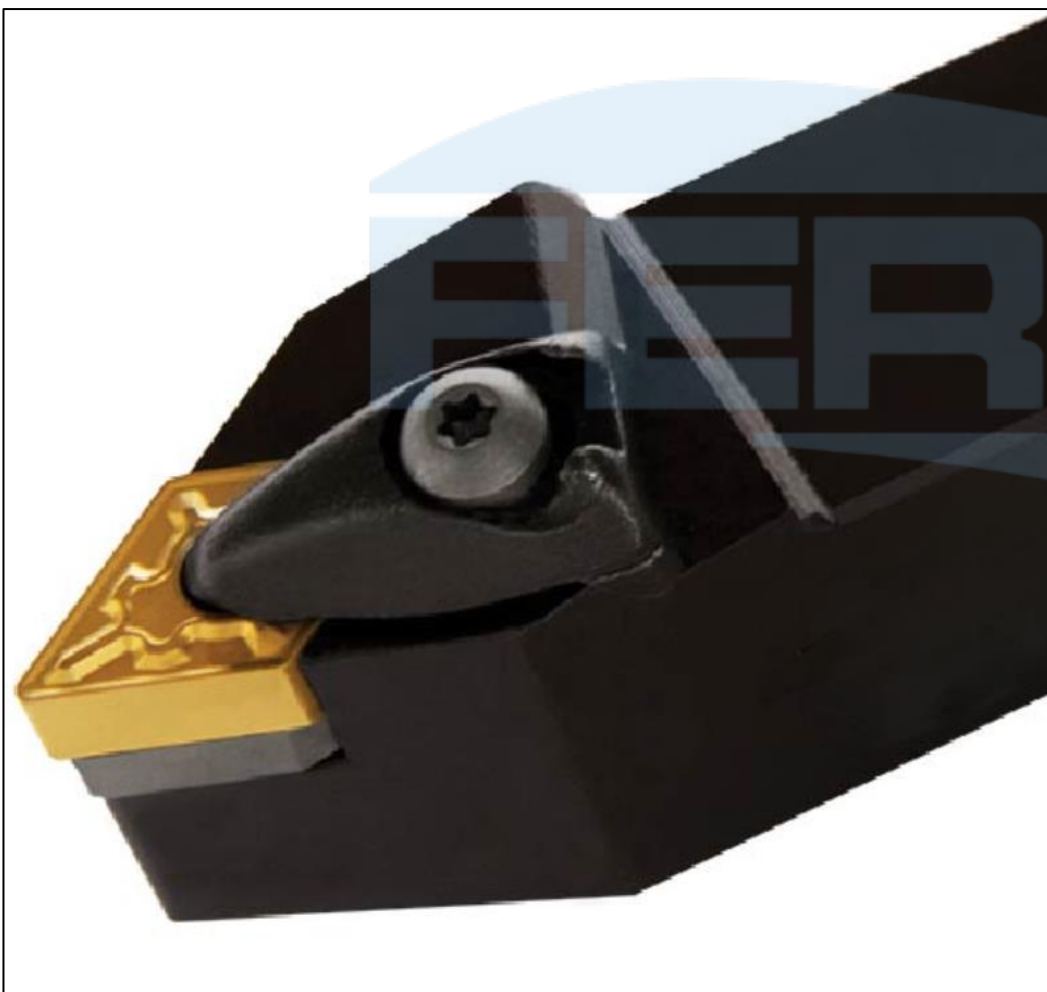



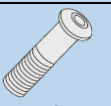





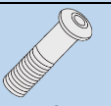
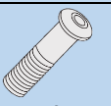

Ilustração na versão direita

| Produtos       | Dimensões (mm) |    |     |      | Pastilha | Acessórios  |  |  |   |   |  |  |
|----------------|----------------|----|-----|------|----------|---|--|--|---|---|--|--|
|                | h              | b  | l   | f    |          |  |  Grampo |  Paraf. do Grampo |  Calço |  Paraf. do Calço |  Pino |  Mola |
| DDNNN 2020 K11 | 20             | 20 | 125 | 10,5 | DN_1104  |  |       |                   |        |                  |       |       |
| DDNNN 2525 M11 | 25             | 25 | 150 | 13   |          |   |  |  |   |   |  |  |
| DDNNN 2525 M15 | 25             | 25 | 150 | 13   | DN_1506  |  |       |                   |        |                  |       |       |
| DDNNN 3225 P15 | 32             | 25 | 170 | 13   |          |   |  |  |   |   |  |  |
| DDNNN 3232 P15 | 32             | 25 | 170 | 16,5 |          |   |  |  |   |   |  |  |
| DDNNN 4040 S15 | 32             | 32 | 170 | 40   |          |   |  |  |   |   |  |  |