

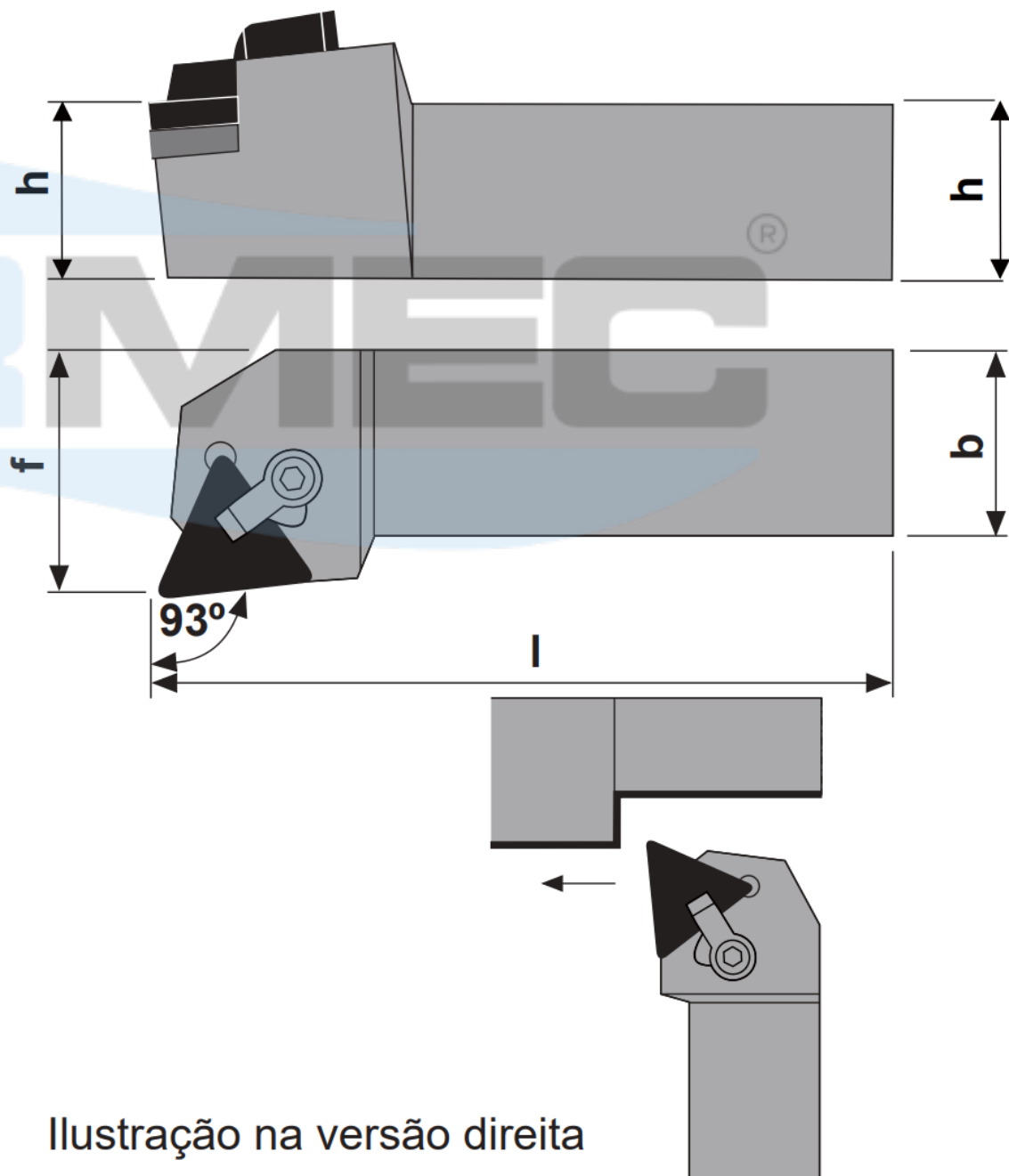

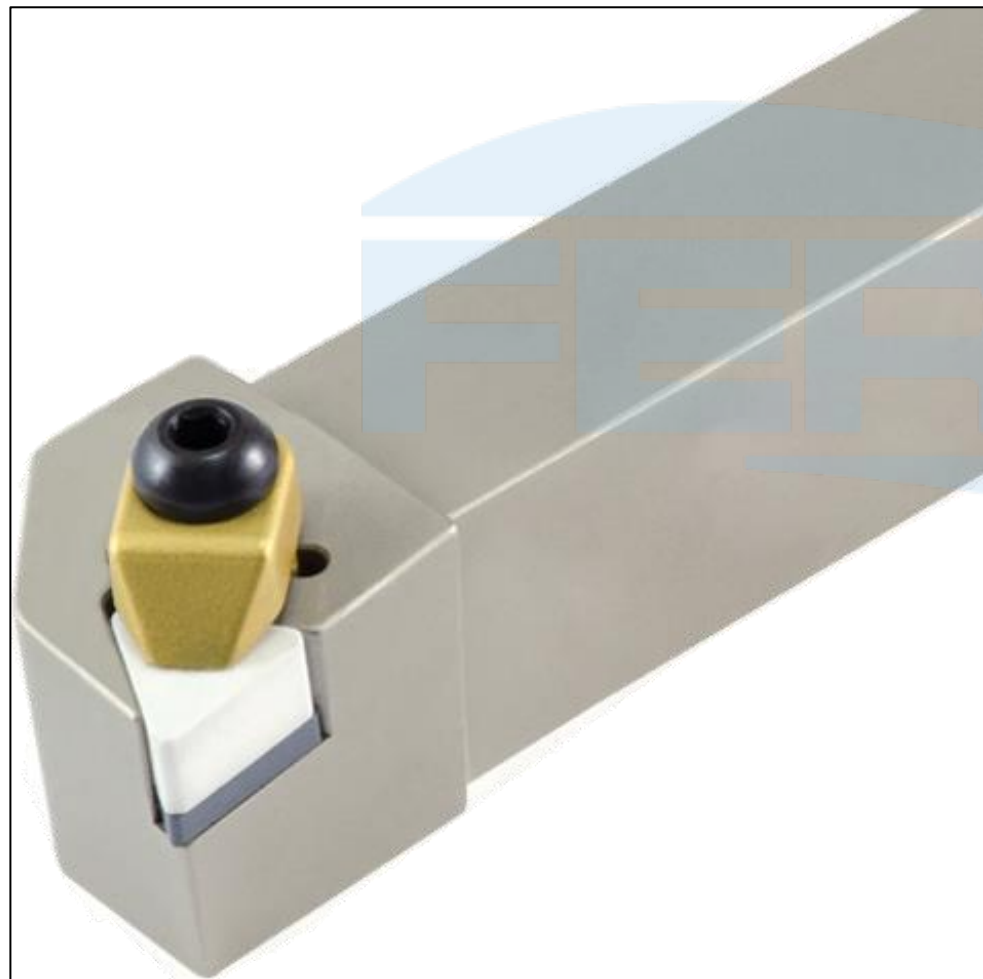

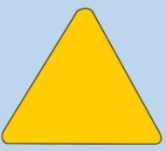



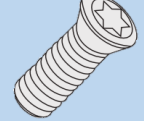

SISTEMA DE FIXAÇÃO POR GRAMPO-PARAFUSO

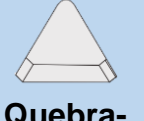
CTJNR

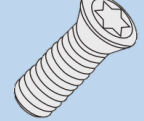
Suporte para torneiar 93° com pastilha negativa triangular

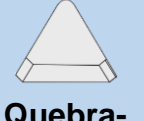

Produtos	Dimensões (mm)				Pastilha	Acessórios											
	h	b	l	f			 Grampo	 Paraf. Torx	 Paraf. do Grampo	 Calço	 Quebra-Cavaco	 Chave Torx					
CTJNR/L 2020 K11-ID	20	20	125	25	TNGN 1103												
CTJNR/L 2525 M11-ID	25	25	150	32								NC - 15	5513.020	LS 103/TX10	HTC.316-02	QCT-8N	TX 7-B TX10-F
CTJNR/L 3225 P11-ID	32	25	170	32													