

SISTEMA DE FIXAÇÃO POR PARAFUSO TORX

SVJCR / SVJBR

Suporte para torneiar e facear 93° com pastilha positiva 35°







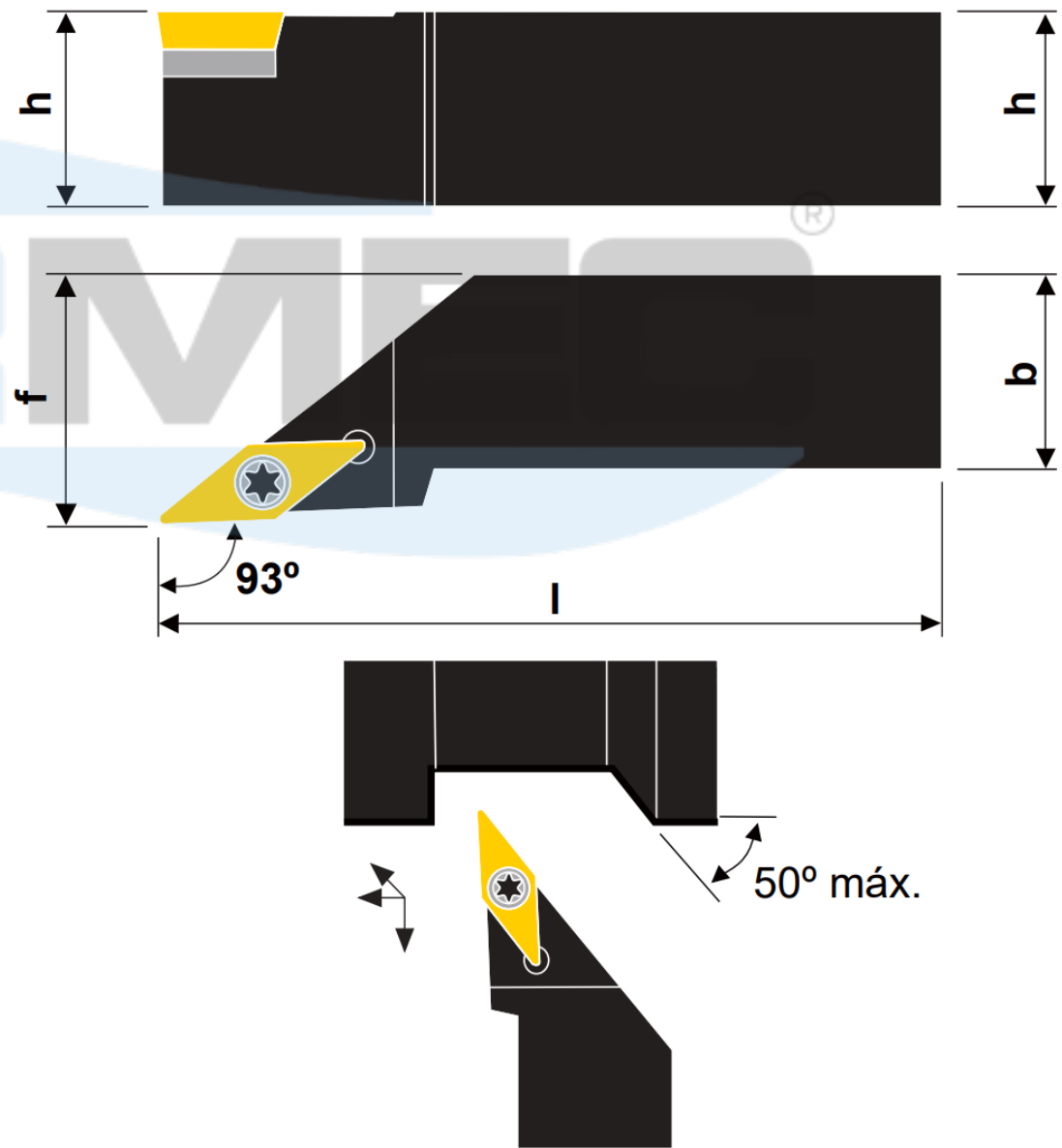
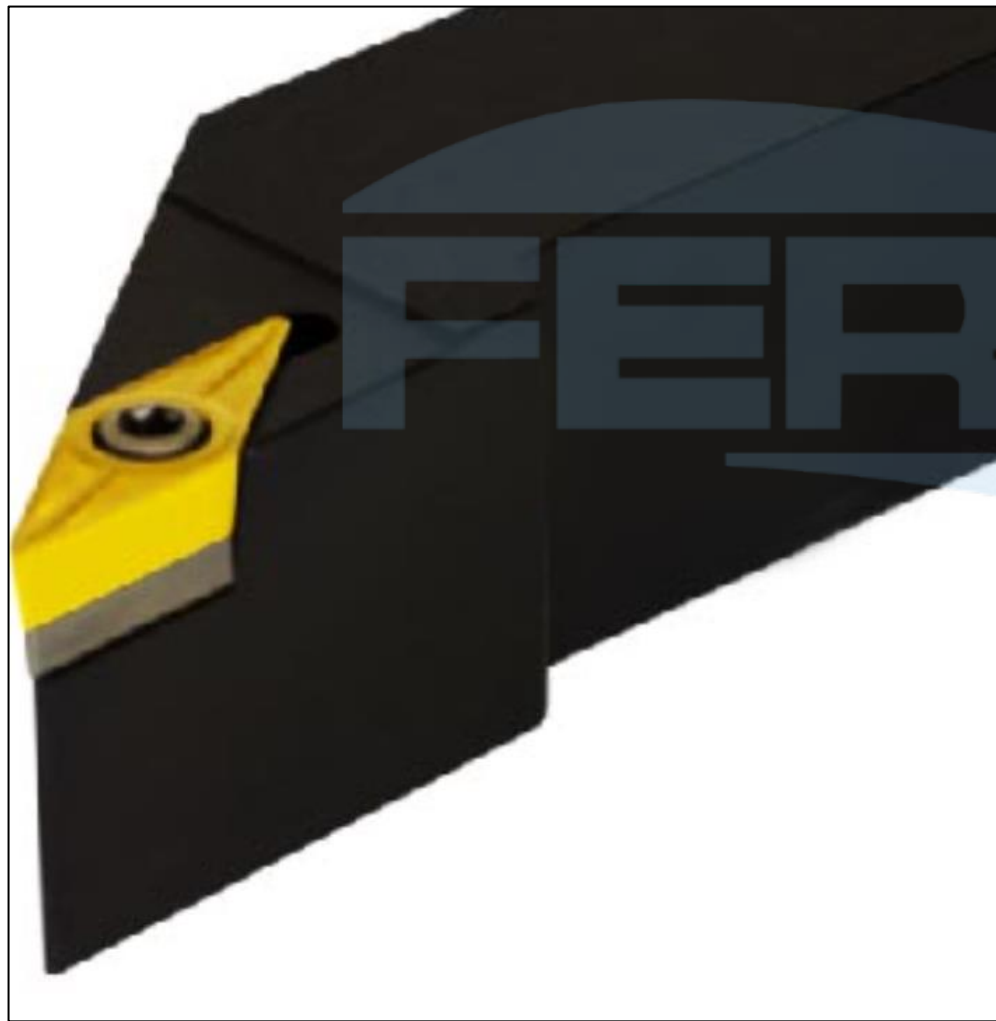
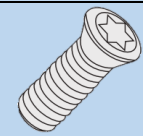
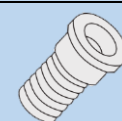

Ilustração na versão direita

Produtos	Dimensões (mm)				Pastilha 	Acessórios			
	h	b	l	f		 Parafuso Torx	 Calço	 Parafuso do Calço	 Chave Torx/Allen
SVJCR/L 1212 F11	12	12	80	16	VB_1103 VC_1103	5513 020-03	-	-	T7-B
SVJCR/L 1616 H11	16	16	100	20					
SVJCR/L 2020 K11	20	20	125	25					
SVJCR/L 2525 M11	25	25	150	32					
SVJCR/L 1010 K11 - S	10	10	125	10					
SVJCR/L 1212 K11 - S	12	12	125	12					
SVJCR/L 1616 K11 - S	16	16	125	16					
SVJBR/L 2020 K16	20	20	125	25	VB_1604 VC_1604	5513 020-01	5322 270-01	5512 090-01	T15-B C - 9/64
SVJBR/L 2525 M16	25	25	150	32					
SVJBR/L 3225 P16	32	25	170	32					