

SISTEMA DE FIXAÇÃO DUPLO POR PINO E GRAMPO

MTSNR

Suporte para torneiar e facear 45° com pastilha negativa 60°

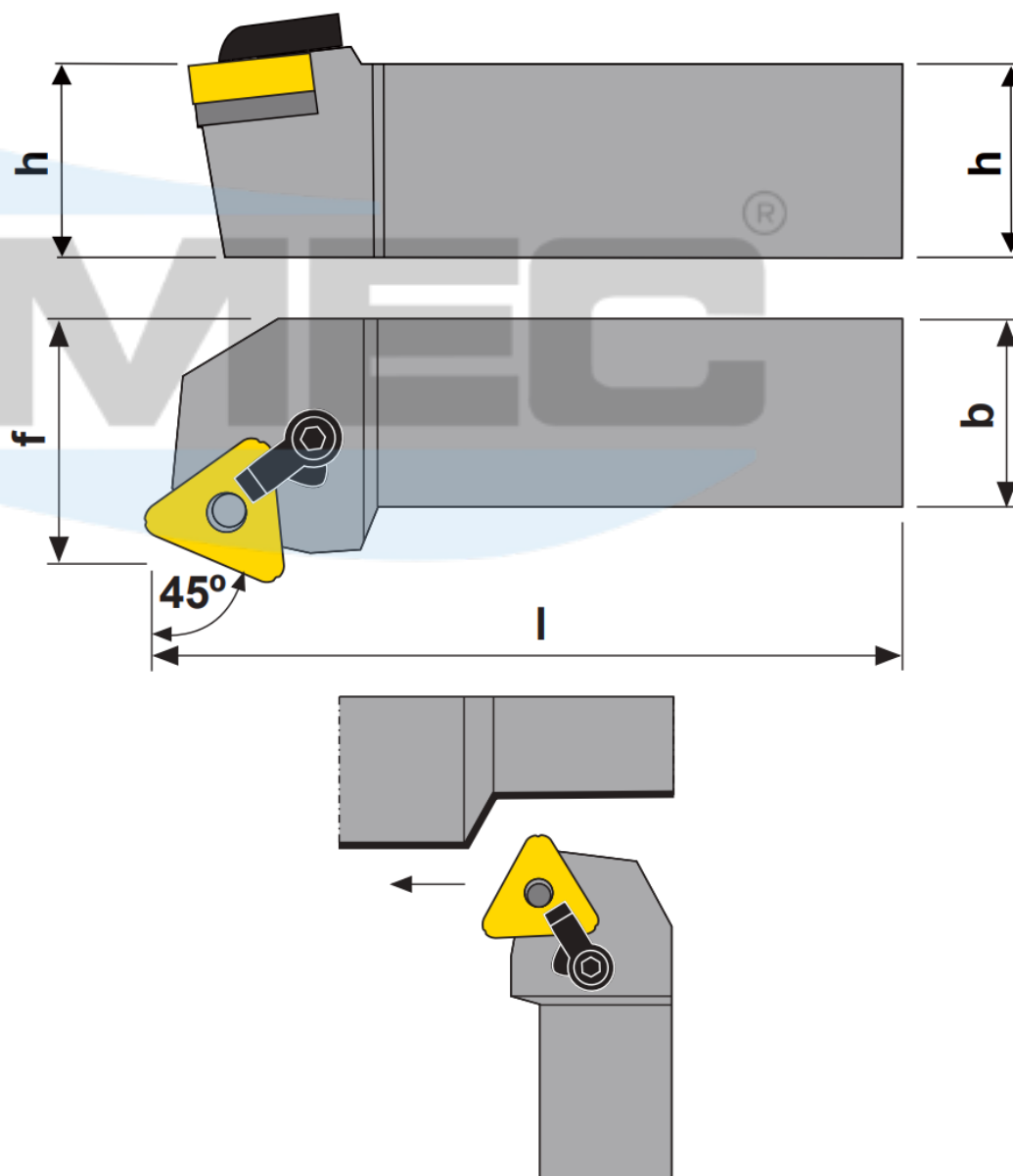

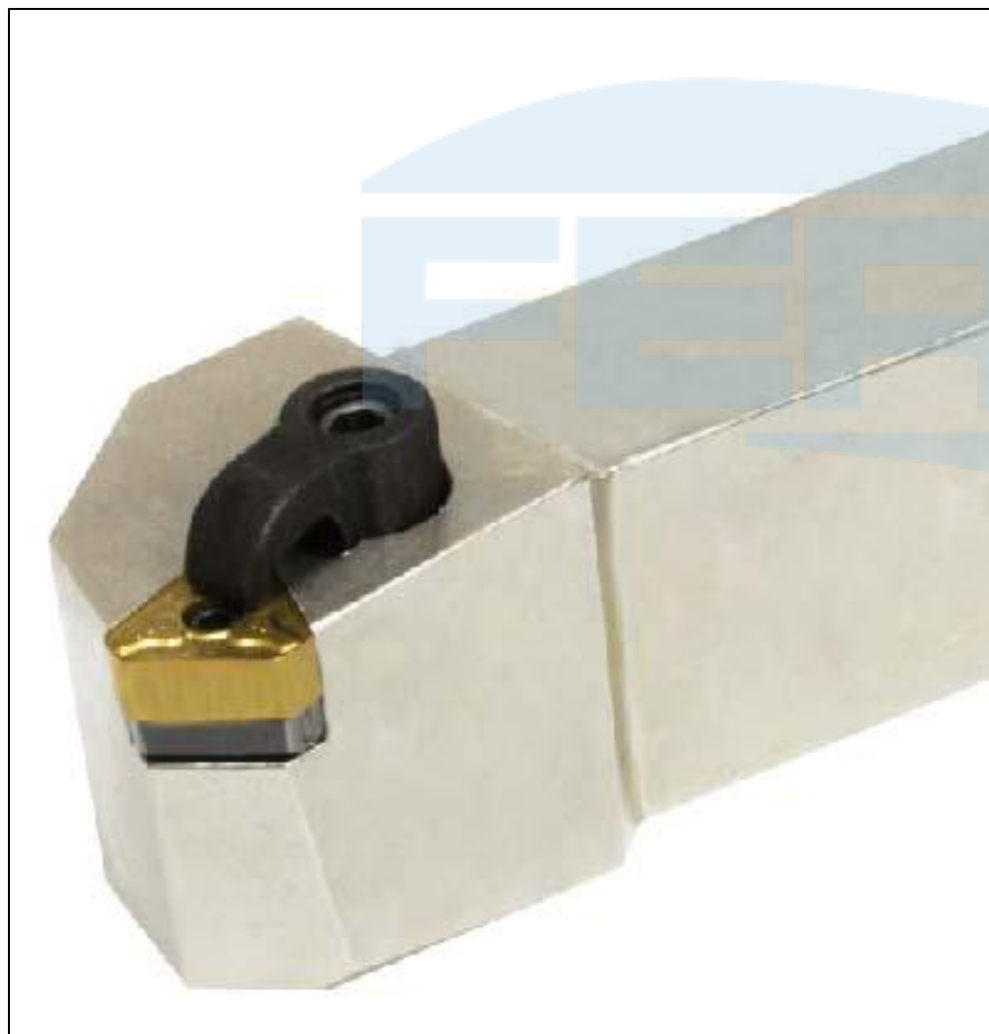
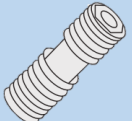

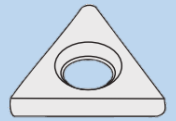

Ilustração na versão direita

Produtos	Dimensões (mm)				Pastilha	Acessórios				
	h	b	l	f			 Grampo	 Parafuso	 Calço	 Pino Paraf. do Calço
MTSNR/L 2020 K16	20	20	125	25	TNMG 1604_Q-RM	NC-20	HT-3	TN16/HM-U	H318-1C	M - 2,0
MTSNR/L 2525 M16	25	25	150	32						
MTSNR/L 2525 M22	32	25	150	32	TNMG 2204_Q-RM	NC-9	HT-2	TN22/HM-U	H308-1C	C - 2,5 C - 4,0
MTSNR/L 3232 P22	32	32	170	40						
MTSNR/L 2525 P27	25	25	150	32	TNMG 2706_Q-RM	NC-9	HT-2	-	NL-58	C-4 / C- 1/8