

FRESA DE TOPO RETO DE METAL DURO - 63HRC

4 CORTES - LONGA

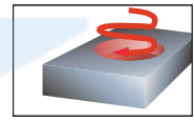
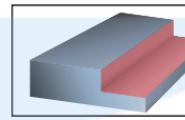
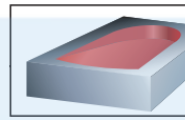
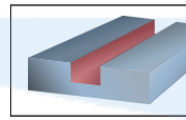
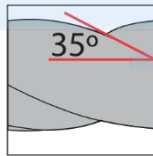
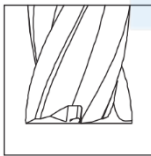
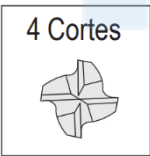
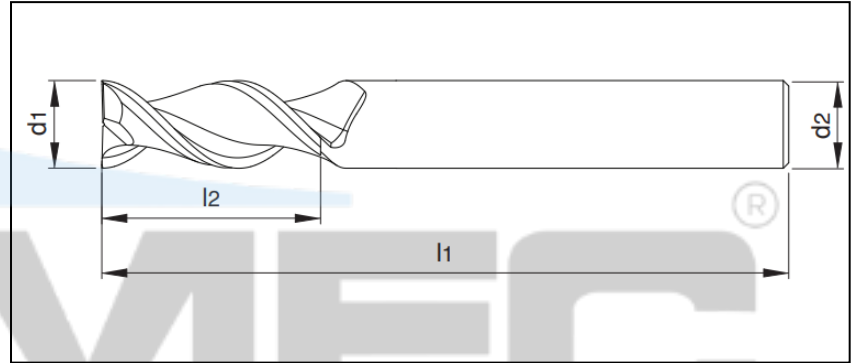
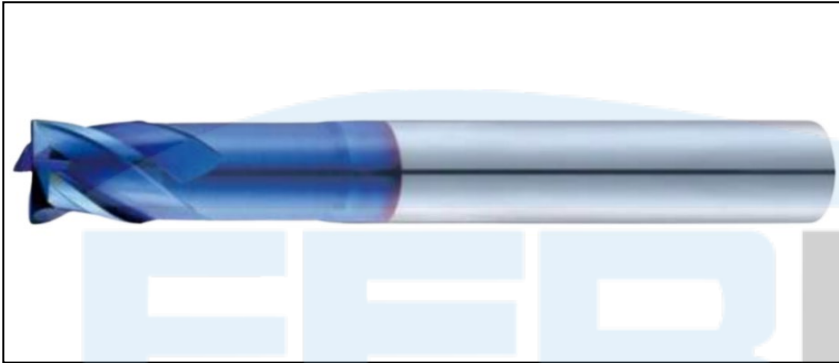

Código	d1	l2	l1	d2
F MD D 13MM 4C L C/C 63HRC	13.0	33	100	13
F MD D 14MM 4C L C/C 63HRC	14.0	35	100	14
F MD D 15MM 4C L C/C 63HRC	15.0	38	100	15
F MD D 16MM 4C L C/C 63HRC	16.0	40	100	16
F MD D 17MM 4C L C/C 63HRC	17.0	40	100	17
F MD D 18MM 4C L C/C 63HRC	18.0	40	100	18
F MD D 19MM 4C L C/C 63HRC	19.0	40	100	19
F MD D 20MM 4C L C/C 63HRC	20.0	40	100	20